



 SPECTRUM™
— Smart TV Display —

Product Manual

Spectrum TV (Front)



Spectrum TV (Back)

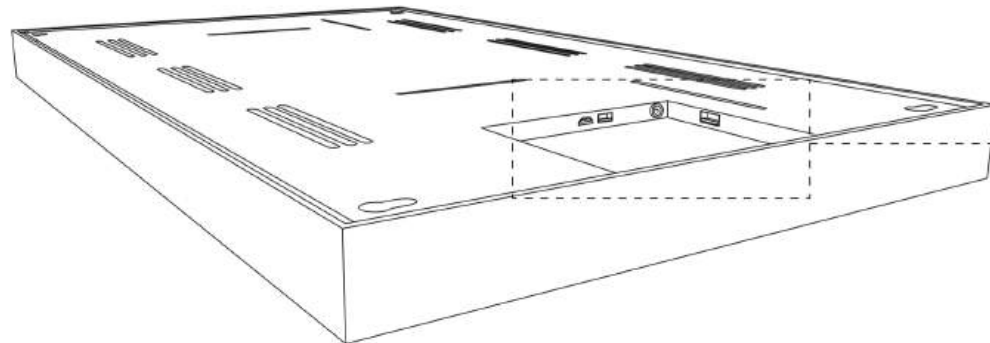

Other Accessories



Evervue Remote



Keyboard and charger

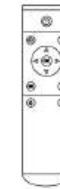

Smart TV Remote

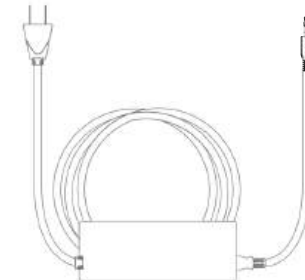

Power Supply

Ports

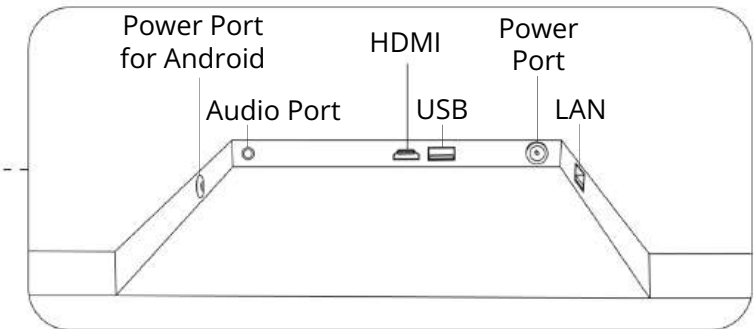

Unboxing

Upon receiving your order, open the crate and inspect the contents. Damages must be reported within 24 hours.

Front

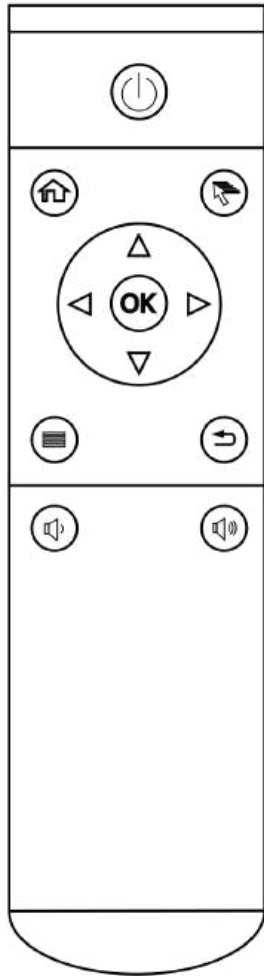

Back

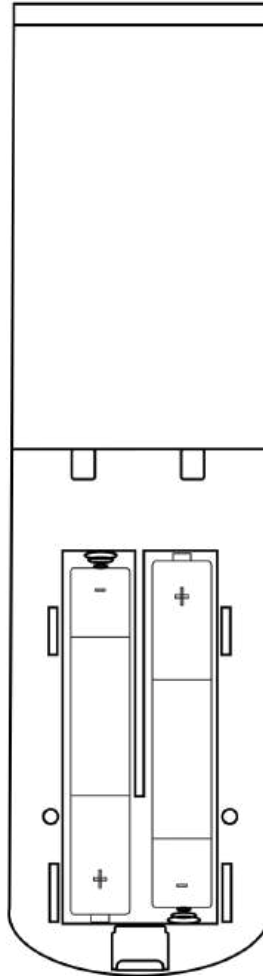



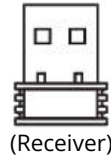

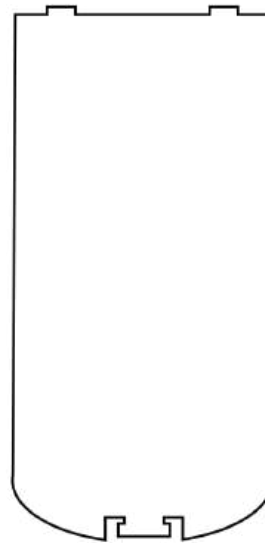

Insert two AAA batteries
At the back of the remote.
(Battery not included)



This receiver connects the mirror to the remote. It is inserted at the back of the mirror.



	Power Button
	Press this to go back to main screen.
	Press this button to point and click on the screen.
	Press this to bring up the T.V. Settings.
	Press this to go back to the page that was previously displayed.
	Press this to raise the volume up.
	Press this to lower the volume down.

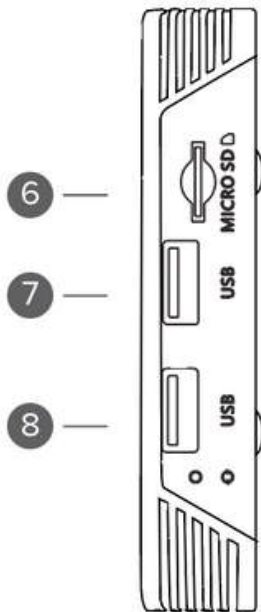
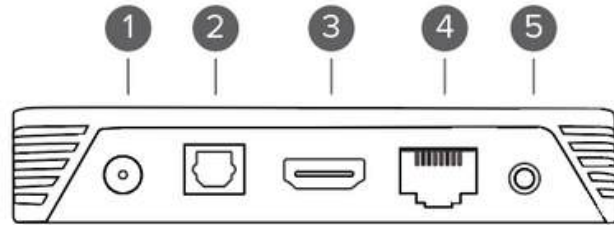

BUTTONS _____

- | | |
|------------------------|------------|
| 1 DC | 5 AV |
| 2 SPDIF | 6 MICRO SD |
| 3 HDMI | 7 USB 3.0 |
| 4 Ethernet Cable (LAN) | 8 USB 2.0 |

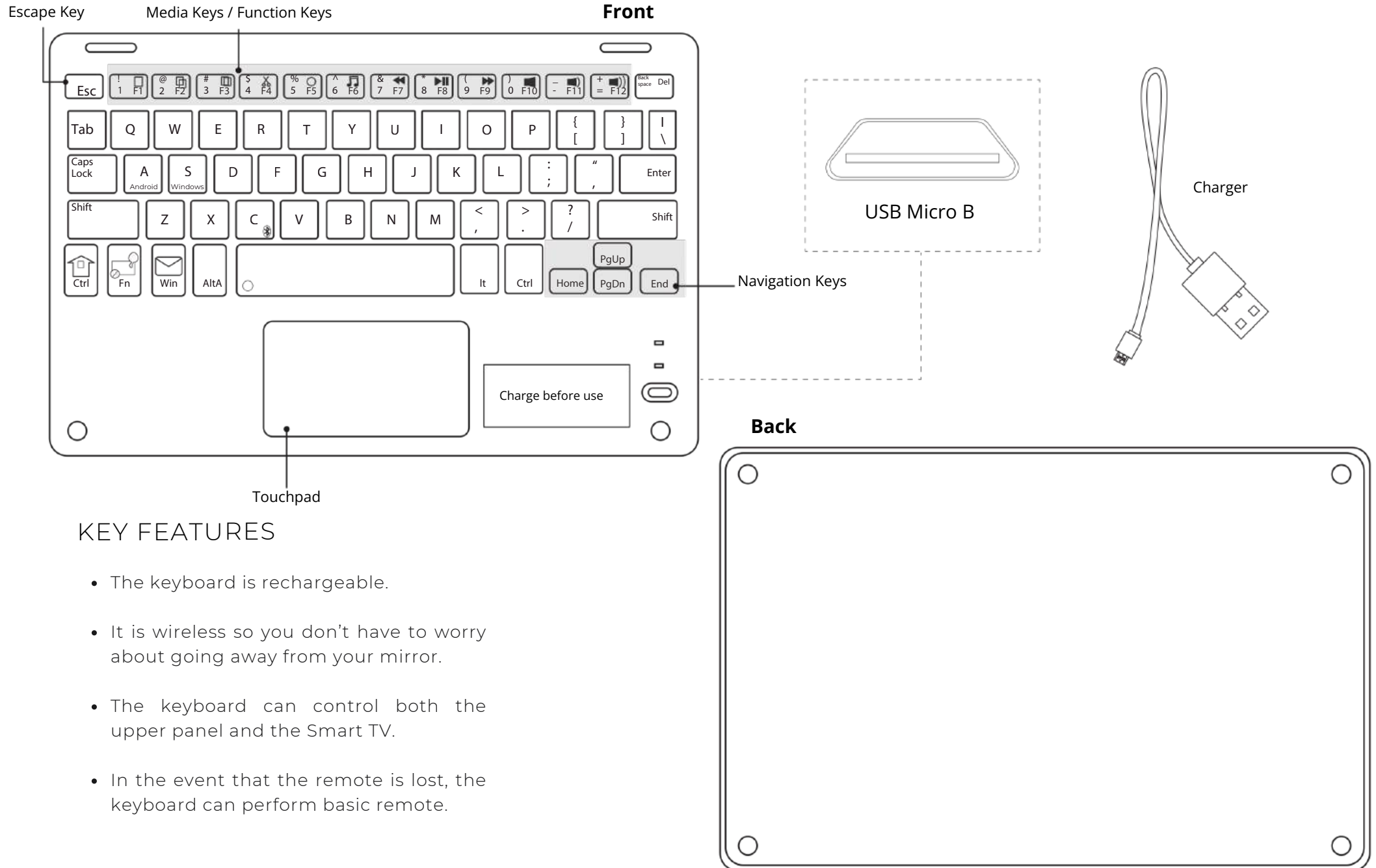

KEY FEATURES

- The keyboard is rechargeable.
- It is wireless so you don't have to worry about going away from your mirror.
- The keyboard can control both the upper panel and the Smart TV.
- In the event that the remote is lost, the keyboard can perform basic remote.

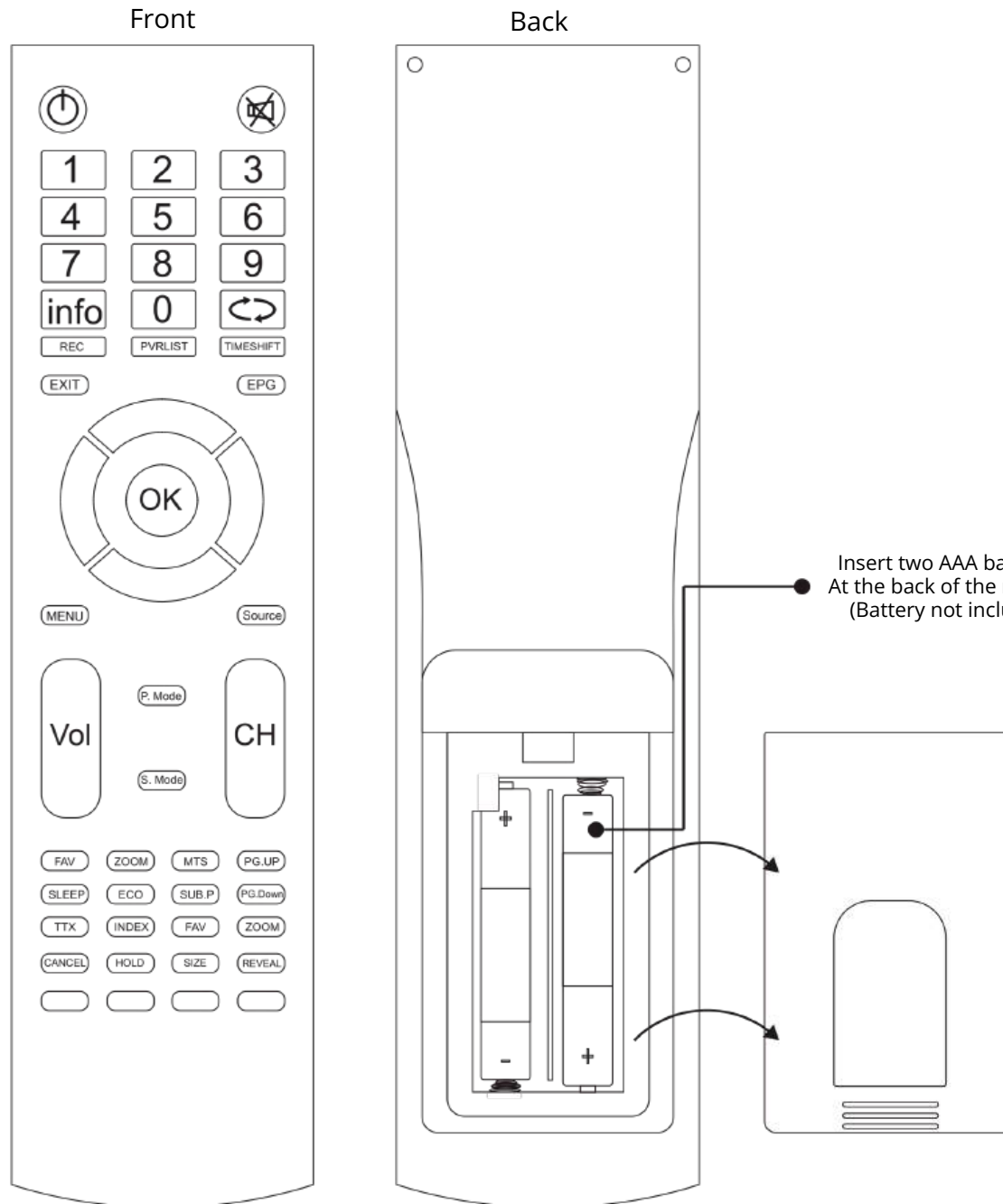

■ The remote controls the Smart T.V.

■ What could you do with this remote?

- Change the brightness and color of the screen
- Change the HDMI input
- Increase the audio volume of the T.V.
- Several more advanced settings

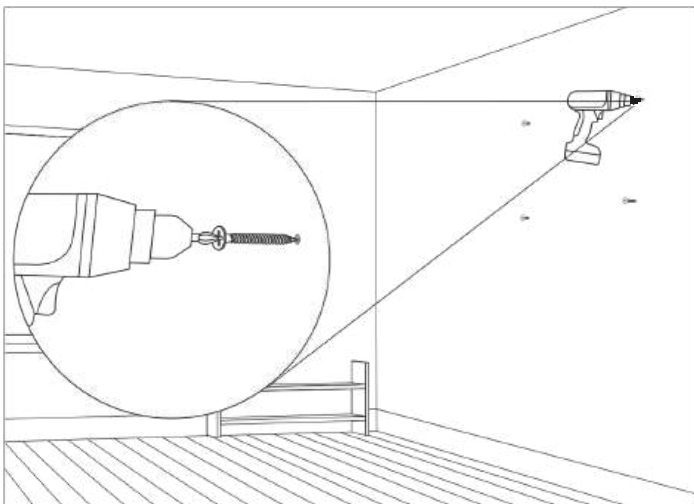

1 Install Four Screws on the Wall

Plan where you're going to install your TV. Mark where the holes of the four corners of the TV would be and drill holes into them. Screw strong, high quality screws on all of the holes.

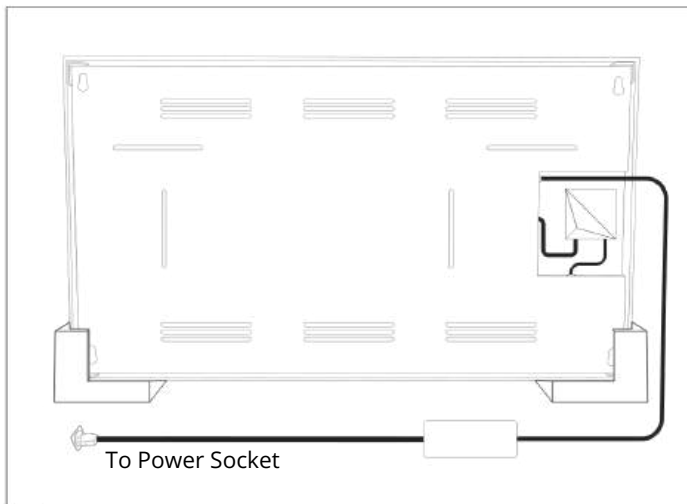

2 Attach the Power Cord

Lay the Spectrum TV on a padded surface and connect the power cord to a power socket.

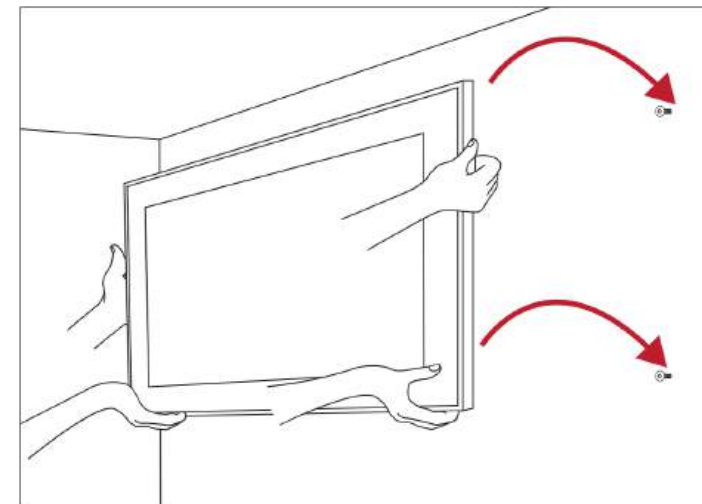

3 Hang the TV

Carefully lift the TV and securely engage the four holes in the corners of the mirror to the screws installed on the wall.

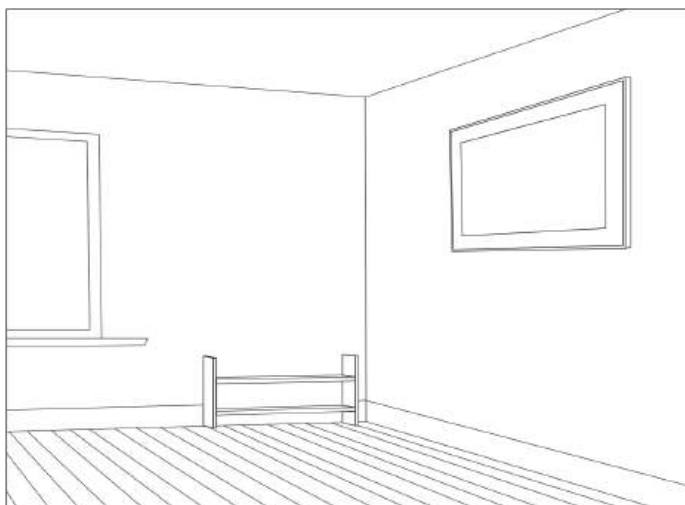

4 Done.

You're done installing the TV. Move on to Initial Setup to activate your TV.

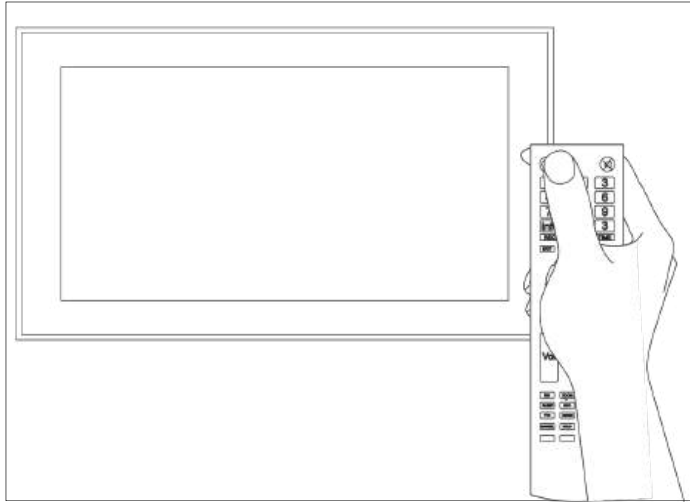

1 Turn the TV On

Turn the TV on by pressing the power button on the TV remote control.

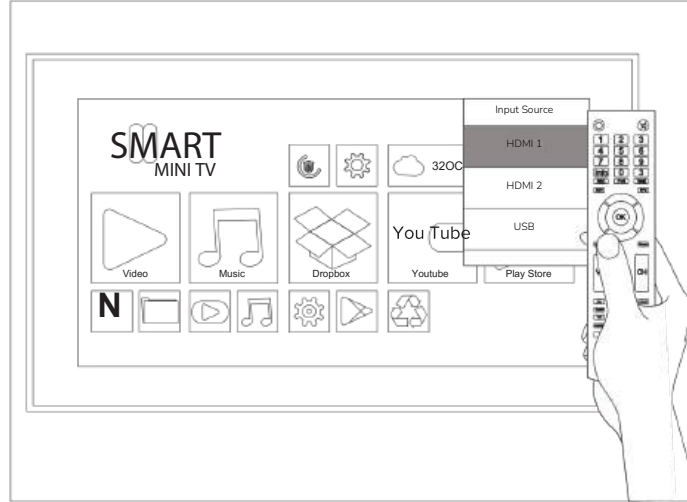

2 Press Source

Press the source button on the remote. On the small source input settings that would pop up, choose and press HDMI 1.

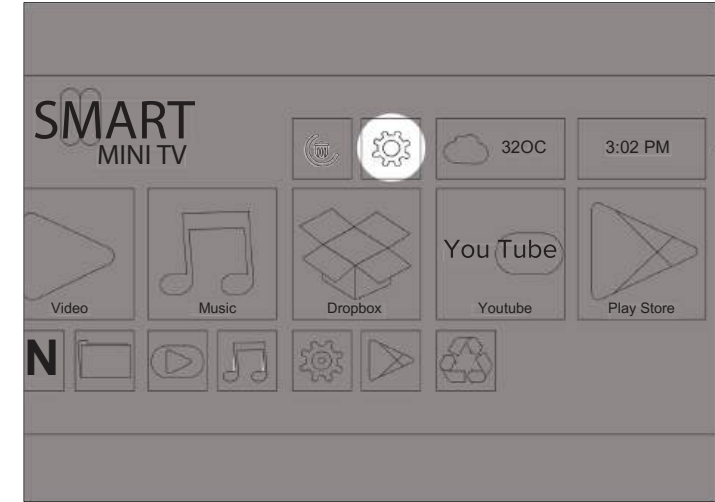

3 Connect to Wifi

Press the settings icon and connect to the internet.

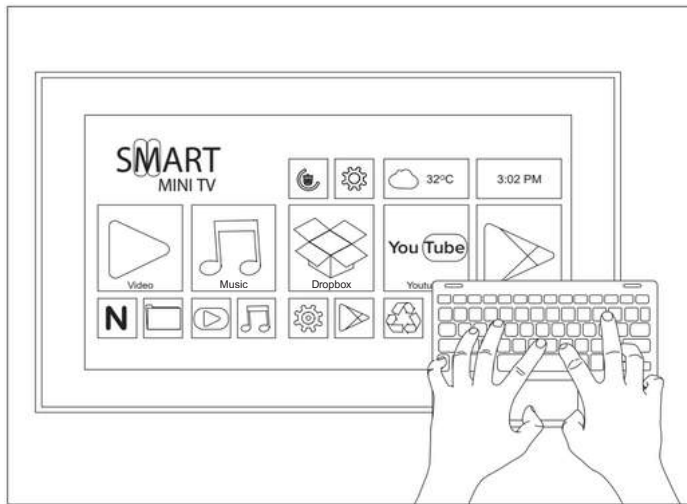

4 Control and Manage Apps

Use the keyboard to navigate through the Spectrum and customize your TV.

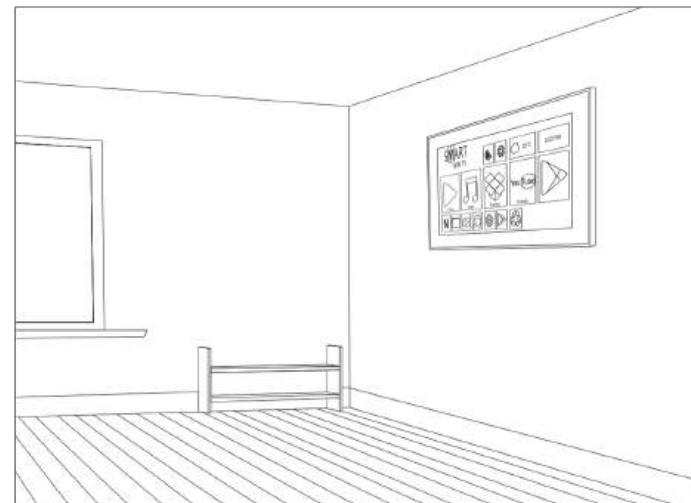

5 Done.

Your Spectrum is ready to use.

Spectrum - How to Install Apps

Option 1: Download from Google Store

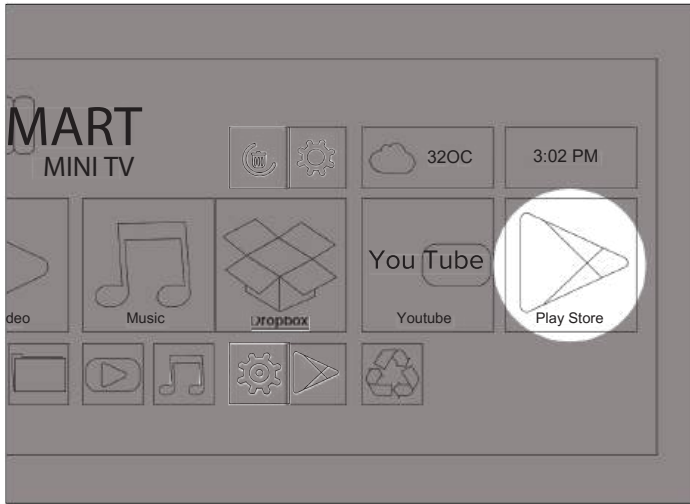

1 Google Play Store
Go to Google Play Store.

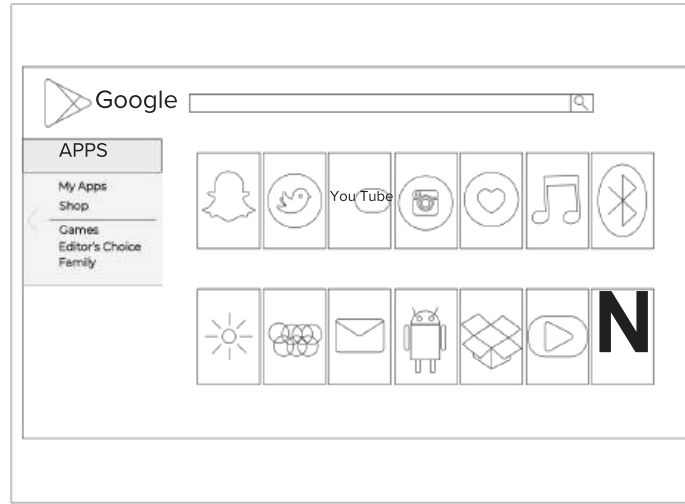

2 Search
Search for the app you wish to install.

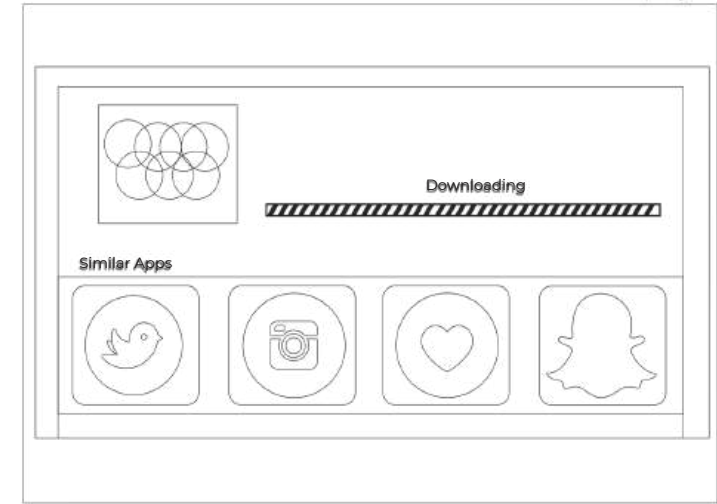

3 Install
Click install and wait for it to finish downloading.

Spectrum - How to Install Apps

Option 2: Download APK

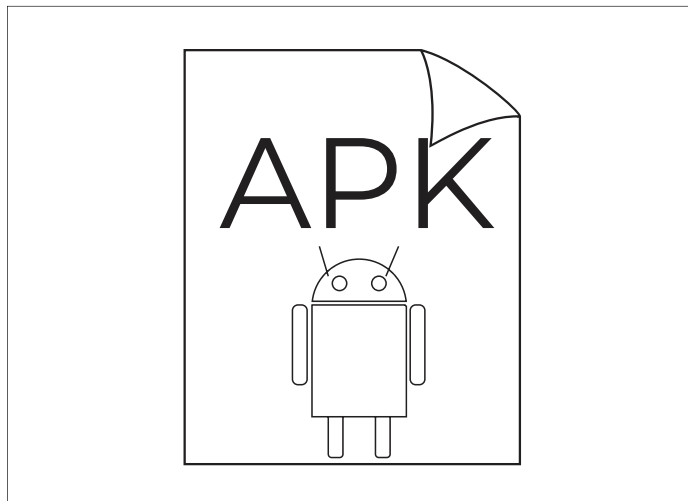

1 Find and Download
Find and download the APK of your desired application online.

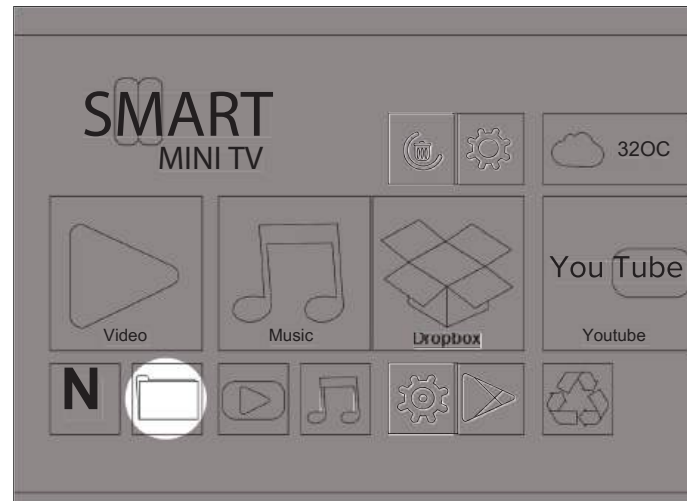

2 Install
Once the download is complete. Go to file manager and find the APK you downloaded. Click it and it will be installed.

Spectrum - Wireless Keyboard Set Up

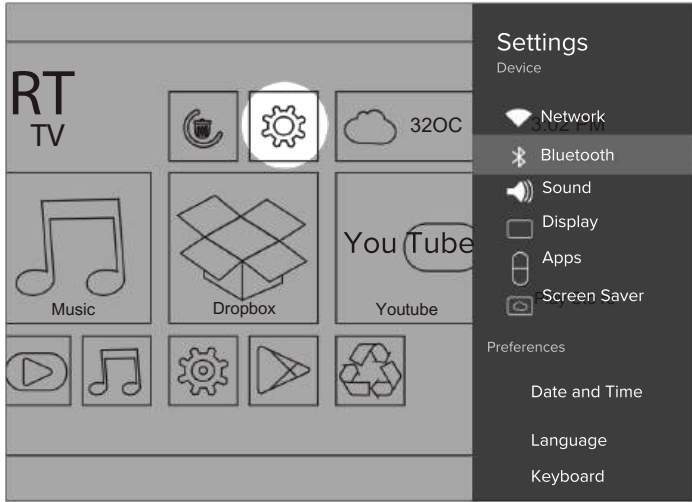

1 Connect via Bluetooth

Go to the settings of your mirror and go to bluetooth.

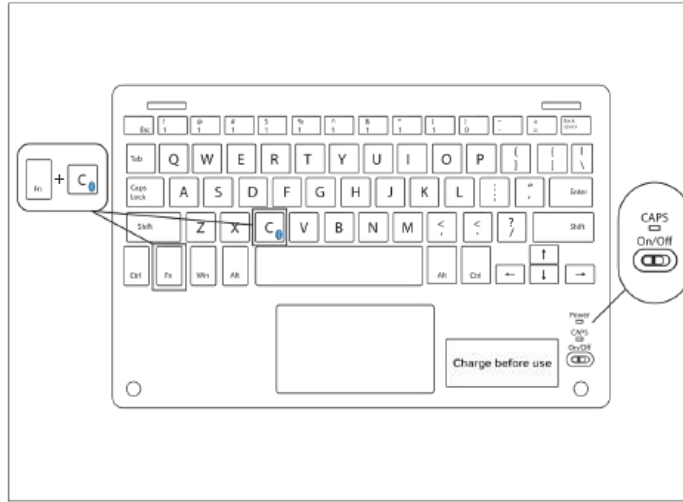

2 Pair Up the Keyboard to the TV

Turn the Keyboard on. Then press the FN+C button to make it discoverable. Initially, the CAPS blue light will turn on if the keyboard is still pairing, once done, it will turn off.

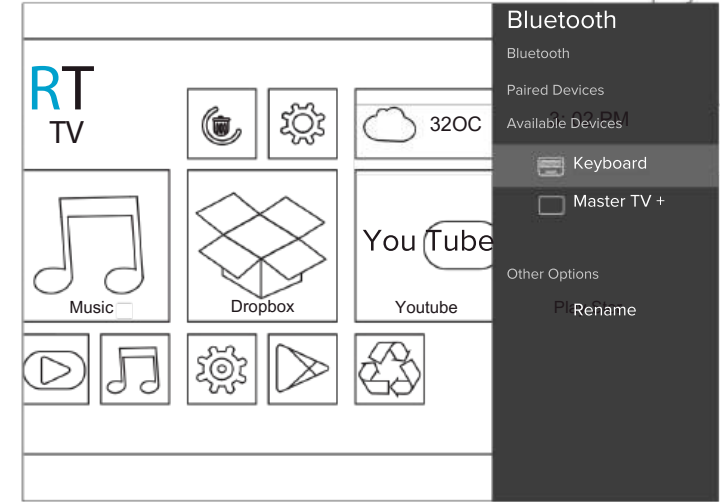

3 Finish Pairing Up

On your TV, click the keyboard under the list of available devices to pair it up.

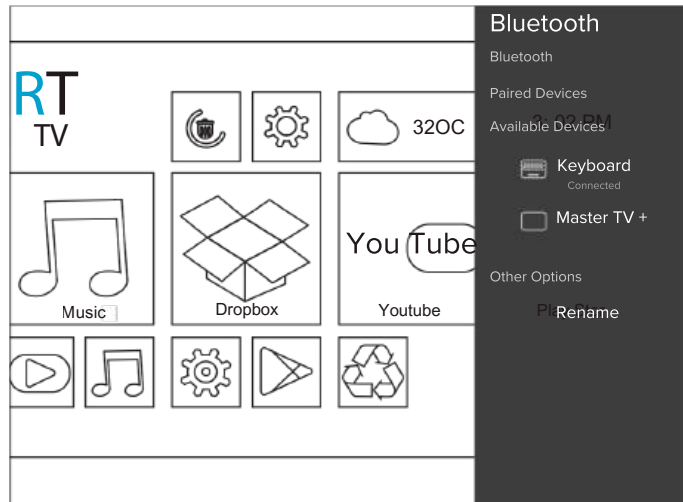

4 Done

Once you see the word "connected" under the keyboard name, your device is ready to use.

Note Charge the wireless keyboard before using it.
The power light will be red while the keyboard is charging and yellow when its done.